

Products > Balls & Hemispheres > Sapphire Hemispheres > H240

# Sapphire Hemispheres - H240

## Specifications

<b>Model</b>	H240
<b>Diameter</b>	.2362"
<b>Diameter (mm)</b>	6.00mm
<b>Thickness</b>	.1181"
<b>Grade</b>	25
<b>Material</b>	Sapphire



### Description

Swiss Jewel supplies hemispheres from materials such as Sapphire, Ruby, Glass, Fused Silica, and Cubic Zirconia which are ideal as Hemispherical Lenses and Spacers. Other sizes and materials are available upon request with typically good delivery time.

### Typical Applications

- Fiber Optics
- LED
- Bar Code Readers

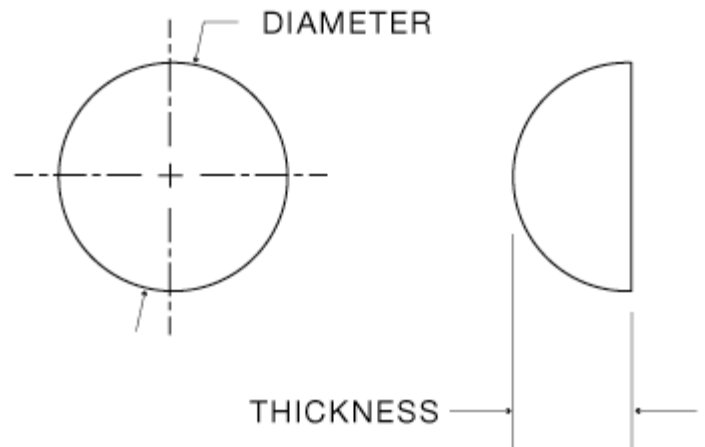

### NOT SEEING EXACTLY WHAT YOU NEED?

We specialize in creating a wide range of custom optical components and custom mechanical components including a variety of shapes - from internal holes and tapers to outer flanges, angles and surface finishes. Contact us and we will consult with you to create a custom component that meets all of your specifications.